

EG21 and EGS21 Series Electric Gage and Swichgage® Installation for Pressure, Temperature, Fuel Level, Voltmeter and Ammeter

Wire/Connector Assembly

NOTE: EG21 Series gage and EGS21 Series Swichgage movement and illumination require 12VDC to function. For 24 or 32 volt systems, voltage converters are built into the electrical wire/connector assembly and supplied with instrument.

Listed below are replacement part numbers for all wire/connector assemblies. Voltage converter included for 24 and 32 volt. Specify part number when ordering.

	12 VDC	24 VDC	32 VDC
EG21P / T / F	05004506	05006166	05006167
EGS21P / T / F	05004507	05006168	05006169
EG21AM	05004505	05006170	05006171
EGS21AM	05004504	05006172	—
EG21VM	05004508	05004508	—
EGS21VM	05004504	05004504	—

Gage Installation

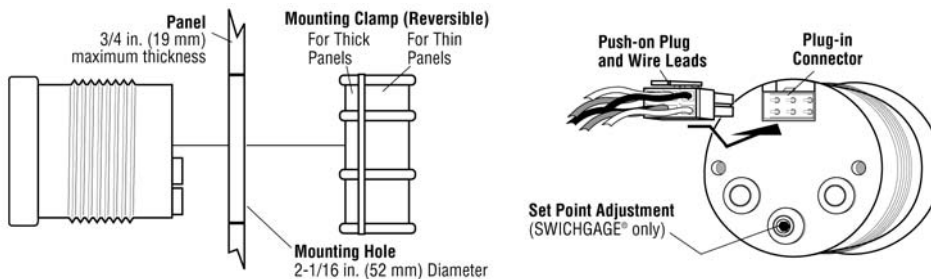

Sharper Accuracy. Higher Durability. Advanced Technology.

The EG21 Series Electric Gage and the EGS21 Series Swichgage instrument take the electric gage to new heights with proven state-of-the-art technology and reliability.



- EG Air Core movement design
- Technological improvements in lighting, accuracy in reading and wiring installation
- Assurance of highest reliability and service
- Environmentally sealed design
- Exceeds the rigid SAE J1810 standard
- Corrosion-resistant materials
- Desirable for marine and other environmentally sensitive applications
- Soft, non-glare dial and pointer illumination by "cold light" LED

Electric Swichgage instrument

The EGS21 Series Swichgage instrument has all of the features of the EG21 Series Gage plus an adjustable set point PowerHall® Effect switch output for operating alarms or equipment shutdown. The trip point is adjustable over 90% of the scale and has a set point indicator visible from the gage face. Now you can have both, the ease of electric gage installation and the reliable switching of Murphy's famous Swichgage instrument.

Dimensions

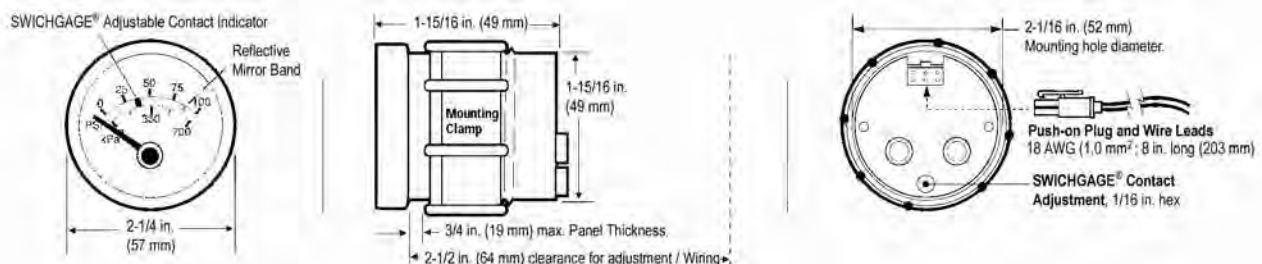

In order to consistently bring you the highest quality, full featured products, we reserve the right to change our specifications and designs at any time. MURPHY, the Murphy logo, and Swichgage® are registered and/or common law trademarks of Murphy Industries, Inc. This document, including textual matter and illustrations, is copyright protected by Murphy Industries, Inc., with all rights reserved. (c) 2008 Murphy Industries, Inc.

Specifications

Power input, all models and sender: 12 VDC or 24 VDC.

Case: Polyester (PBT), impact and weather resistant with screw-on mounting clamp.

Bezel: Polished 316 stainless steel standard; available in black, SAE style optional.

Lens: Clear Polycarbonate and UV stabilized.

Air Core Movement: Silicon dampened pointer.

Dial: Black with white markings; back-lite (marking becomes red when illuminated); dual scale with mirror band to reduce parallax reading errors.

Swichgage Instrument Sensor: PowerHall[®] Effect; outputs ground signal (sinking output) rated: 300 mA continuous (EGS21 models). Pressure, Fuel, Volts set on decreasing scale. Temperature and Amps set on increasing scale. Output saturation voltage (voltage drop across switch): 1.3-2.3 Volts @ 25°C (may require some conditioning to work with logic inputs).

Swichgage instrument Set Point Indicator: Visible on mirror band (scale); adjustable from the back of the unit (1/16 in. hex type wrench).

Wiring: Plug connector with wire leads, 18 AWG (1.0 mm²), 8 in. (203 mm) long.

Operating Temperature: -40 to 185°F (-40 to +85°C).

Storage Temperature: -77 to 185° F (-60 to +85°C).

Over voltage (Gage Movement): Withstands 200% of nominal system voltage for 5 min. Meets SAE J1810.

Reversed Polarity (Gage Movement): Withstands reversed battery terminal polarity indefinitely within operating temperatures.

Environment and Test: Meets SAE J1810 standards

Sender Installation

CAUTION: Do not use sender body to tighten. If sealant tape or pipe dope is used on the pressure sender, be sure that the tape or dope does not plug the sender's orifice.

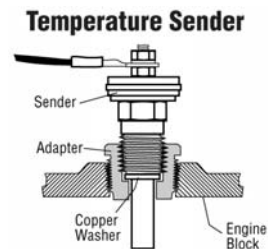
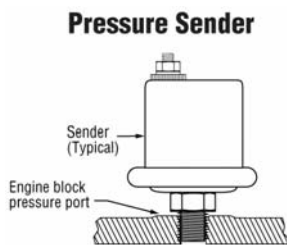

CAUTION: Extreme caution must be used in handling or working on or around the fuel tank. It must be worked on only in a WELL VENTILATED area. Keep all flame and hot materials away from it. Do not smoke while working on or around the tank. Avoid sliding or dragging the tank, or other actions which may cause a spark.

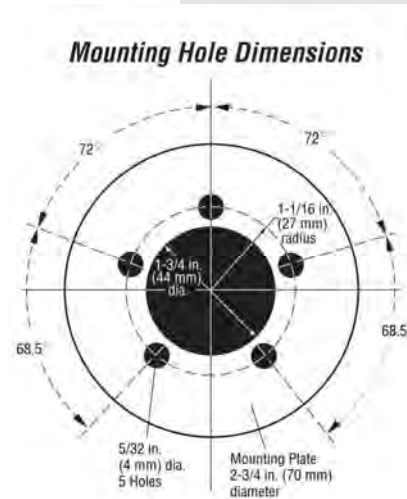

Fuel Level Sender

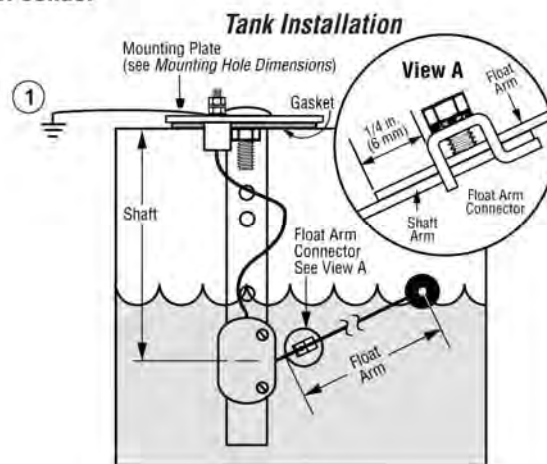

NOTE: When installing the fuel sender in a non-metallic tank using a single wire sender, another wire must be added from one of the sender mounting bolts to the battery ground (negative post). See ① in the 'Tank Installation' illustration above.

Basic Wiring

WARNING: Disconnect battery negative cable before wiring or service.

Pressure, Temperature, Fuel Level and Voltmeter Gage

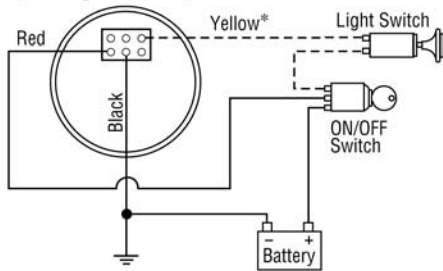

Ammeter Gage

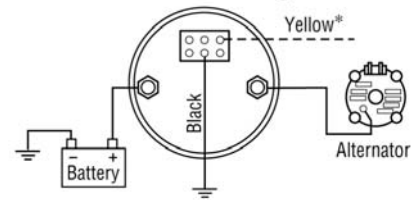

*Yellow wire is optional for gage illumination and does not need to be connected for gage to operate.

Sender Wiring

Grounded Sender

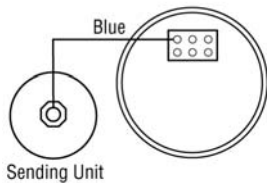

Ungrounded Sender

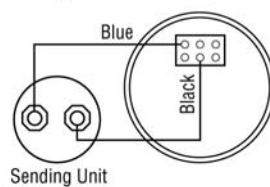

Dual Gages with Dual Gage Sender

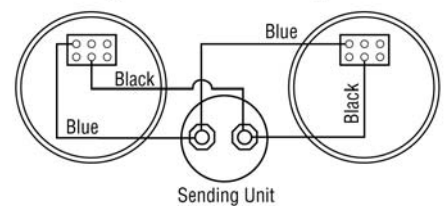

Swichgage Wiring

WARNING: DISCONNECT BATTERY NEGATIVE CABLE BEFORE WIRING OR SERVICE.

CAUTION: Connecting full Battery potential to the brown wire can damage the Switchgage. Shutdown circuit is rated for 300 mA continuous, 900 mA inrush. Circuit sinks to battery negative at set point.

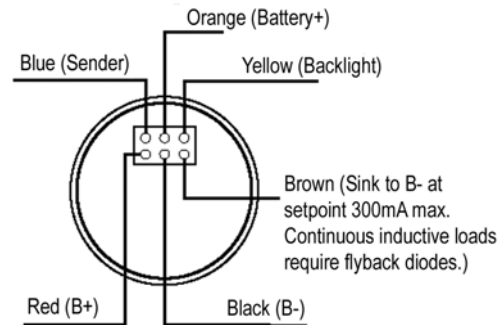
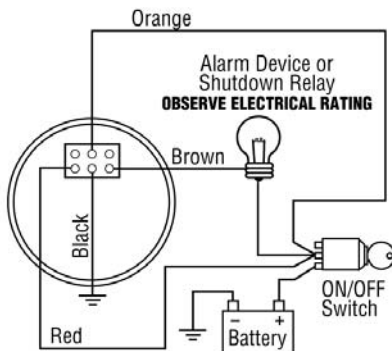

CAUTION: Devices containing solid state components can be damaged or caused to malfunction when used in systems which incorporate inductive loads (e.g. relays, solenoids, etc.) that can generate voltage spikes.

To reduce the potential for this type of damage, install a flyback or clamping diode across all inductive loads (see wiring diagram below).

Use Murphy diode package 65-00-0343 or equivalent. A typical diode is 1N4005 which is readily available from commercial sources. Failures of this type are not covered by our Limited Warranty.

Warranty - A limited warranty on materials and workmanship is given with this FW Murphy product. A copy of the warranty may be viewed or printed by going to www.fwmurphy.com/support/warranty.htm

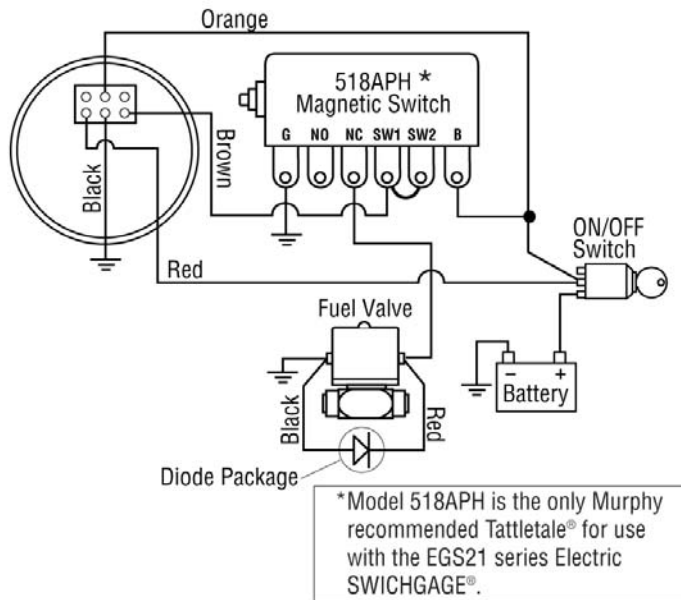

NOTE: Do not connect 117PH or power on TL7 to brown wire. Only use 518(A)PH or 760 Tattletale indicators. Pilot a relay with a flyback diode across the coil for loads pulling more current than rated.

In 2008, surge absorber harnesses were shipped with the EGS21 family of Swichgag Instrument. These surge absorbers are now built into the EGS21's with Date Code E-5 (May 2009) or later. The external surge absorber harness is no longer needed. It will not cause any problems if it is used with the new EGS21's.

WARNING!

Some applications have electrical transients that can damage the EGS21 gage and leave no apparent sign of failure. To prevent this failure mode from affecting the EGS and other systems, always install flyback diodes across all inductive loads.

In 2008, surge absorber harnesses were shipped with the EGS21 family of Swichgag[®] instruments. These surge absorbers are now built into the EGS21's with Date Code E-5 (May 2009) or later. The external surge absorber harness is no longer needed. It will not cause any problems if it is used with new EGS21's. Always fuse the circuit appropriately. Failure to do so may result in potential damage to wiring.

NOTICE

The EG21 and EGS21 series Swichgag requires 12VDC to operate.

To support 24VDC and 32VDC systems, the harness is specifically designed to convert the supply voltage to 12VDC to operate the gage.

Refer to document (included) 00-02-0251 EG21 & EGS21 Series Electric Gage and Swichgag Installation. The latest version can be found at www.fwmurphy.com

FW MURPHY
P.O. Box 470248
Tulsa, Oklahoma 74147 USA
Phone: +1 918 317 4100 Fax: +1 918 317 4266
E-mail: sales@fwmurphy.com

INDUSTRIAL PANEL DIVISION
Fax: +1 918 317 4124
E-mail: ipdsales@fwmurphy.com

MURPHY POWER IGNITION
Web site: www.murphy-pi.com

CONTROL SYSTEMS & SERVICES DIVISION
P.O. Box 1819
Rosenberg, Texas 77471 USA
Phone: +1 281 633 4500 Fax: +1 281 633 4588
E-mail: css-solutions@fwmurphy.com

FRANK W. MURPHY LTD.
Church Road, Laverstock
Salisbury, SP1 1QZ, UK
Phone: +44 1722 410055 Fax: +44 1722 410088
E-mail: sales@fwmurphy.co.uk
Web site: www.fwmurphy.co.uk

COMPUTRONIC CONTROLS
41 - 46 Railway Terrace
Nechells, Birmingham, B7 5NG, UK
Phone: +44 121 327 8500 Fax: +44 121 327 8501
E-mail: sales@comptroniccontrols.com
Web site: www.comptroniccontrols.com

www.fwmurphy.com

FW MURPHY INSTRUMENTS (HANGZHOU) CO., LTD.
77 23rd Street
Hangzhou Economic & Technological Development Area
Hangzhou, Zhejiang, 310018, China
Phone: +86 571 8788 8060 Fax: +86 571 8684 8878
E-mail: apcsales@fwmurphy.com



USA REG. NO. 2888 FM 2027
UK REG. NO. 2888 FM 2027
Registered Supplier

ISO 9001
CERTIFIED

Printed in U.S.A.

12/02/09